

## FEATURES

- NON-FLAMMABLE RESIN INSULATION
- HIGH STABILITY AND RELIABILITY
- LOW NOISE
- LOW COST ALTERNATIVE TO CARBON COMPOSITION AND WIREWOUND APPLICATIONS
- NEW REDUCED SIZES
- EIA COLOR CODING AND ALPHA-NUMERICAL CODING AVAILABLE DEPENDING ON SIZE

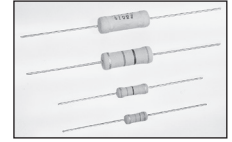

**RoHS**  
**Compliant**  
includes all homogeneous materials

\*See Part Number System for Details

## STANDARD TYPES, RATINGS AND AVAILABILITY

Type	NMO100	NMO200	NMO300	NMO500	NMO700
Power Rating at 70°C	1 Watt	2 Watt	3 Watt	5 Watt	7 Watt
Max. Working Voltage at 70°C**	350V	350V	500V	750V	800V
Max. Overload Voltage at 70°C	600V	600V	800V	1000V	1500V
Max. Pulse Voltage at 70°C	750V	750V	1500V	2000V	2000V
Resistance Range	±5% (J) Tol. ±2% (G) Tol.	0.22Ω ~ 50KΩ	0.22Ω ~ 50KΩ	0.22Ω ~ 100KΩ	0.22Ω ~ 200KΩ
Resistance Value Availability	E-24	E-24	E-24	E-24	E-24
Axial Taping Availability	Yes	Yes	No	No	No

## REDUCED SIZE, RATING AND AVAILABILITY

Type	NMO100S	NMO200S	NMO300S	NMO500S	NMO700S
Power Rating at 70°C	1 Watt	2 Watt	3 Watt	5 Watt	7 Watt
Max. Working Voltage at 70°C**	350V	350V	350V	500V	750V
Max. Overload Voltage at 70°C	600V	600V	600V	800V	1000V
Max. Pulse Voltage at 70°C	750V	750V	750V	750V	1200V
Resistance Range	±5% (J) Tol. ±2% (G) Tol.	0.22Ω ~ 50KΩ	0.22Ω ~ 50KΩ	0.22Ω ~ 100KΩ	0.22Ω ~ 200KΩ
Resistance Value Availability	E-24	E-24	E-24	E-24	E-24
Axial Taping Availability	Yes	Yes	Yes	No	No

\* Special Order \*\* - Maximum allowable continuous voltage (Vdc or rms) for all resistors is the lower of the two values: "MAXIMUM WORKING VOLTAGE" as specified, or  $\sqrt{\text{Power rating (WATT)} \times \text{Resistance (OHMS)}}$

## CHARACTERISTICS

Requirements	Performance	Test Method & Conditions JIS C 5201-4 and IEC 60115-4
Operating Temperature Range	-55 ~ +155°C (Derated above 70°C as per derating curve below)	
Withstanding Voltage (Insulation Characteristics)	>1,000MΩ	Measured between lead wire and component body.
Temperature Coefficient	±300ppm/°C	From +55°C ~ +155°C
Short Time Overload	ΔR Std ≤ ±1%, Reduce Size ≤ ±2%	2.5x rated voltage for 5 seconds
Temperature Cycling	ΔR ≤ ±1%	-55°C for 30 min., room temp. for 3 min., +155°C for 30 min., room temp. for 3 min. (5 cycles)
Soldering Effect	ΔR ≤ ±1%	Two leads dipped in +350°C for 3.5±0.5 seconds
Vibration	ΔR ≤ ±1%	10Hz - 55Hz - 10Hz, 2 hrs each directions (X,Y,Z), 1.5mm amplitude
Moisture Resistance	ΔR ≤ ±5%	+40±2°C, 90~95% RH 1.5 hours on, 0.5 hours off (500 hours)
Load Life	ΔR ≤ ±5%	+70°C 1.5 hours on, 0.5 hours off, 1000 hours

## TYPICAL PERFORMANCE

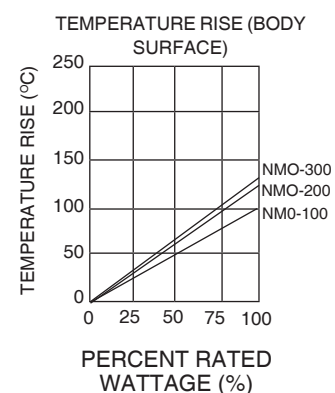
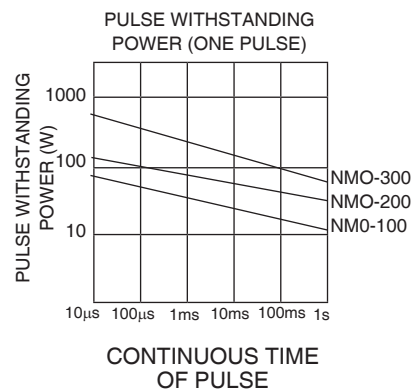
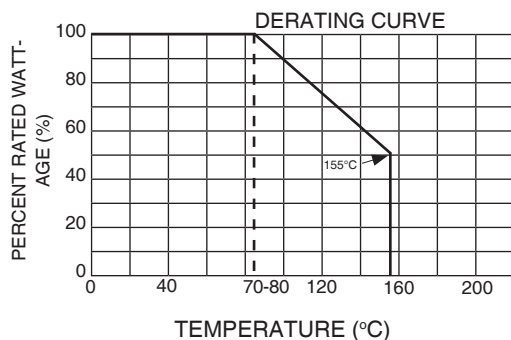

## DIMENSIONS (mm)

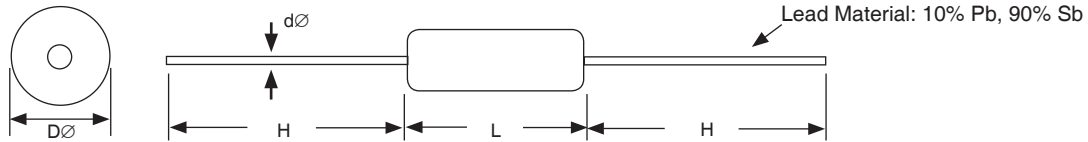

Type	Dimensions (mm)			
	Dφ ± 1.0	L ± 1.0	H ± 3.0	dφ ± 0.10
NMO100	4.5	11	28	0.80
NMO200	5.0	15	28	0.80
NMO300	8.5	24	38	0.80
NMO500	8.5	41	38	0.80
NMO700	8.5	53	38	0.80

Type	Dimensions (mm)			
	Dφ ± 1.0	L ± 1.0	H ± 3.0	dφ ± 0.10
NMO100S	3.5	9.0	28	0.65
NMO200S	4.5	11	28	0.80
NMO300S	5.0	15	28	0.80
NMO500S	8.5	24	38	0.80
NMO700S	8.5	41	38	0.80

## COLOR CODING

Color	Significant Figure			Multiplier	Tolerance
	1st	2nd	3rd		
Black	0	0	0	1	-
Brown	1	1	1	10	-
Red	2	2	2	100	G (±2%)
Orange	3	3	3	1,000	-
Yellow	4	4	4	10,000	-
Green	5	5	5	-	-
Blue	6	6	6	-	-
Violet	7	7	7	-	-
Grey	8	8	8	-	-
White	9	9	9	-	-
Gold	-	-	-	0.1	J (±5%)
Silver	-	-	-	0.01	-

## SIGNIFICANT VALUES OF NOMINAL RESISTANCE E-24 5% (J)

1.0	2.2	4.7
1.1	2.4	5.1
1.2	2.7	5.6
1.3	3.0	6.2
1.5	3.3	6.8
1.6	3.6	7.5
1.8	3.9	8.2
2.0	4.3	9.1

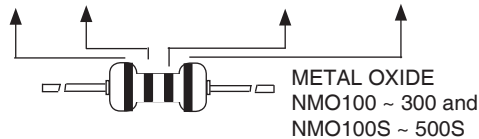

## MARKING (FOR 500, 700S & 700)

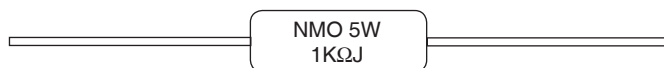

## PART NUMBER SYSTEM

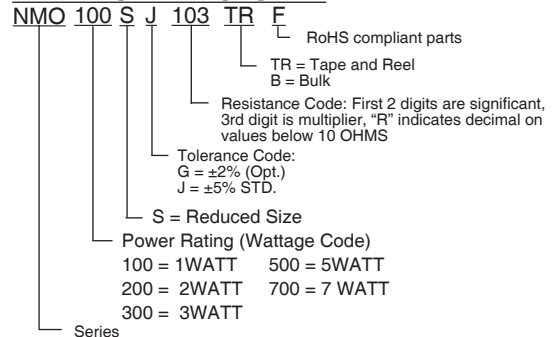

# Resistor Taping Specifications & Mechanical Characteristics

## TAPE

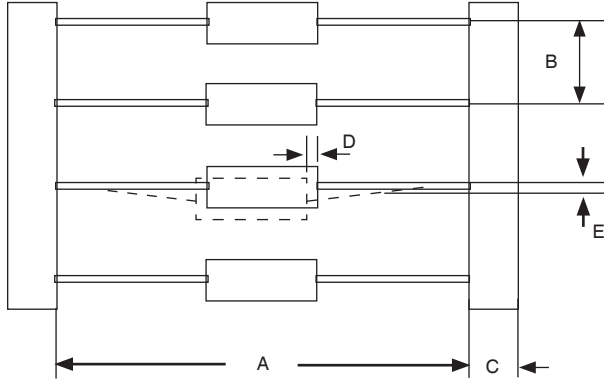

## TAPE DIMENSIONS (mm)

Type		A	B	C	D max.	E max.
NMO100S	-	52 ± 1.0	5.0 ± 0.5	6.0 ± 1.0	0.6	1.2
NMO200S	NMO100	63 ± 1.0	5.0 ± 0.5	6.0 ± 1.0	0.6	1.2
NMO300S	NMO200	63 ± 1.0	10.0 ± 1.0	6.0 ± 1.0	0.6	1.2
		76 ± 1.5	10.0 ± 1.0	6.0 ± 1.0	0.6	1.2

## REEL DIMENSIONS (mm)

Type		Tape Width	A nom.	B nom.	C nom.	F nom.
NMO100S	-	52	310	75	54	15
NMO200S	NMO100	63				
NMO300S	NMO200	63				
		76		90		

## REEL

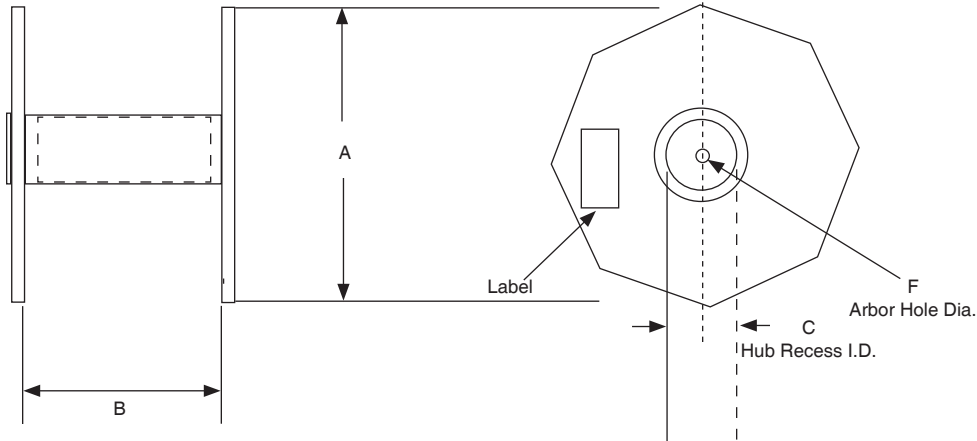

## MECHANICAL CHARACTERISTICS

### LEAD PULL TEST

The lead wire shall withstand steady pull of the following weight axially to the lead wire for the minimum period of 10 seconds without any breakage or damage:

Nom. Lead Diameter	0.4φmm	0.5φmm	0.6φmm	0.7φmm	0.8φmm & over
Steady Weight	1.0Kgs.	1.0Kgs.	1.5Kgs	2.0Kgs.	2.5Kgs.

### LEAD BEND TEST

The lead wire shall withstand minimum 4 bends of 90° rotation without any breakage or damage, when the resistor is placed in a vertical position and is applied with a weight of 0.5Kgs for 0.4 - 0.5mm or 1.1Kgs for 0.6mm and over lead wire.

### SOLDERABILITY

The lead wire is immersed into 10% methanol or isopropyl alcohol of rosin by weight for a period of 2 ± 0.5 seconds. Then, it shall be dipped into molten solder melted at 230 ± 5°C for a period of 5 ± 1 seconds approximately 1.5mm from the body of the resistor. A new adhering coating of solder shall cover minimum 95% of the surface being dipped into solder.

### RESISTANCE TO CLEANING SOLVENTS

Color coating or marking shall remain legible after cleaning by solvents such as isopropyl alcohol, trichloroethylene, freon® TF/TAX, xylene etc., in form of liquid or gas.

